

# Pneumatically driven piston pump unit of the series PPS30

Assembly instructions

acc. to Machinery Directive 2006/42/EC

EN



Version 06  
951-170-220-EN



## EC Declaration of Incorporation according to Machinery Directive 2006/42/EC, Annex II Part 1 B

The manufacturer SKF Lubrication Systems Germany GmbH , Berlin Motzener Strasse 35/37, DE - 12277 Berlin hereby declares that the partly completed machinery:

Designation: **Pneumatically driven piston pump unit**  
 Type: **PPS30** Part no.: **PPS30-...** Year of construction: See type identification plate

complies with the following basic requirements of the EC Machinery Directive 2006/42/EC at the time when first being launched in the market.

1.1.2 · 1.1.3 · 1.3.2 · 1.3.4 · 1.5.1 · 1.5.6 · 1.5.8 · 1.5.9 · 1.6.1 · 1.7.1 · 1.7.3 · 1.7.4

The special technical documents were prepared following annex VII part B of this directive. Upon justifiable request, these special technical documents can be forwarded electronically to the respective national authorities. The person empowered to assemble the technical documentation on behalf of the manufacturer is the head of standardization; see manufacturer's address.

Furthermore, the following directives and harmonized standards were applied in the respective applicable areas:

2011/65/EU

RoHS II

2014/30/EU

Electromagnetic compatibility | Industry

Standard	Edition	Standard	Edition	Standard	Edition	Standard	Edition
DIN EN ISO 12100	2011	DIN EN 60947-5-1	2010	DIN EN 61000-6-2	2006	DIN EN 61000-6-4	2011
DIN EN 809	2012	DIN EN 61131-2	2008	Amendment	2011	DIN EN 60947-5-1	2010
DIN EN 60204-1	2007	Amendment	2009	DIN EN 61000-6-3	2011		
Amendment	2010	DIN EN 60034-1	2015	Amendment	2012		
DIN EN 50581	2013	DIN EN 61000-6-1	2007				

The partly completed machinery must not be put into service until the final machinery into which it is to be incorporated has been declared in conformity with the provisions of the EC Machinery Directive 2006/42/EC and any other applicable directives.

Berlin 2015/01/03

Jürgen Kreutzkämper  
 Manager R&D Germany  
 SKF Lubrication Business Unit



Dr.-Ing. Holger Schmidt  
 Manager Development Center Berlin  
 SKF Lubrication Business Unit



## Legal disclosure

### Manufacturer

SKF Lubrication Systems Germany GmbH  
 Manufacturer's facilities  
 Headquarter  
Walldorf Facilities  
 Heinrich-Hertz-Str. 2-8  
 69190 Walldorf  
 Deutschland  
 Phone: +49 (0) 6227 33-0  
 Fax: +49 (0) 6227 33-259

#### Berlin Facilities

Motzener Straße 35/37  
 12277 Berlin  
 Germany  
 Phone +49 (0)30 72002-0  
 Fax +49 (0)30 72002-111  
[www.skf.com/lubrication](http://www.skf.com/lubrication)

#### Hockenheim Facilities

2. Industriestraße 4  
 68766 Hockenheim  
 Germany  
 Phone +49 (0)62 05 27-0  
 Fax +49 (0)62 05 27-101  
 E-mail: [Lubrication-germany@skf.com](mailto:Lubrication-germany@skf.com)  
[www.skf.com/lubrication](http://www.skf.com/lubrication)

### Training courses

In order to provide a maximum of safety and economic viability, SKF carries out detailed training courses. It is recommended that the training courses are attended. For more information please contact the respective SKF Service address.

### Copyright

© Copyright SKF.

All rights reserved.

### Warranty

The instructions do not contain any information on the warranty. This can be found in our general terms and conditions.

### Disclaimer

The manufacturer shall not be held responsible for damages caused by:

- non appropriate use, faulty assembly, operation, setting, maintenance, repair or accidents
- improper or late response to malfunctions
- unauthorized modifications of the product
- intent or negligence
- the use of non-original SKF spare parts





















Liability for loss or damage resulting from the use of our products is limited to the maximum purchase price. Liability for consequential damages of whatever kind is excluded.

# Table of contents



EC Declaration of Incorporation.....	2		
Legal disclosure .....	3		
Explanation of symbols and signs.....	6		
<b>1. Safety instructions.....</b>	<b>8</b>	<b>2. Lubricants .....</b>	<b>18</b>
1.1 General safety instructions.....	8	2.1 General information .....	18
1.2 General behaviour when handling the product.....	8	2.2 Selection of lubricants.....	18
1.3 Intended use.....	9	2.3 Material compatibility.....	19
1.4 Foreseeable misuse.....	9	2.4 Ageing of lubricants.....	19
1.5 Painting of plastic parts.....	10	<b>3. Overview, functional description.....</b>	<b>20</b>
1.6 Modifications of the product.....	10	3.1 Product codes.....	21
1.7 Prohibition of certain activities.....	10	3.2 General information .....	22
1.8 Inspections prior to delivery .....	10	3.3 Functional description of single-line systems .....	22
1.9 Other applicable documents.....	10	3.4 Functional description of the pneumatic piston pump .....	24
1.10 Information label on product.....	11	<b>4. Technical data.....</b>	<b>26</b>
1.12 Notes related to the CE marking .....	12	4.1 General technical data.....	26
1.11 Note on the rating plate .....	12	<b>5. Delivery, returns, and storage.....</b>	<b>28</b>
1.13 Persons authorized to operate the pump .....	13	5.1 Delivery .....	28
1.13.1 Operator.....	13	5.2 Returns .....	28
1.13.2 Specialist in mechanics .....	13	5.3 Storage.....	28
1.13.3 Specialist in electrics .....	13		
1.14 Briefing of external technicians.....	13		
1.15 Provision of personal protective equipment.....	13		
1.16 Operation.....	13		
1.17 Emergency stopping of the pump station .....	13		
1.18 Transport, installation, maintenance, malfunctions, repair, shutdown, disposal .....	14		
1.19 Initial commissioning / daily start-up.....	15		
1.20 Cleaning .....	15		
1.21 Residual risks .....	16		

<b>6.</b>	<b>Assembly .....</b>	<b>29</b>	<b>10.</b>	<b>Maintenance .....</b>	<b>42</b>
6.1	General information .....	29	10.1	Maintenance schedule .....	42
6.2	Setup and attachment .....	29	<b>11.</b>	<b>Troubleshooting .....</b>	<b>43</b>
6.2.1	Minimum mounting dimensions.....	30	11.1	Commissioning, product, and system malfunctions .....	44
6.2.2	Hydraulic layout.....	30	<b>12.</b>	<b>Repairs .....</b>	<b>46</b>
6.3	Port dimensions, assembly holes, and minimum mounting dimensions .....	31	<b>13.</b>	<b>Shutdown and disposal .....</b>	<b>46</b>
6.4	Assembly of the product.....	32	13.1	Temporary shutdown .....	46
6.5	Compressed air line connection .....	33	13.2	Final shutdown and disassembly .....	46
6.6	Lubrication line connection .....	35	13.3	Disposal.....	46
6.7	Assembly of the lubrication lines using SKF plug connectors.....	36	<b>14.</b>	<b>Spare parts .....</b>	<b>47</b>
6.8	Connection of electrical pressure switch and fill level switch.....	37	<b>15.</b>	<b>Accessories .....</b>	<b>48</b>
6.9	Venting the centralized lubrication system .....	38			
<b>7.</b>	<b>Initial start-up .....</b>	<b>39</b>			
7.1	Inspections prior to initial start-up .....	39			
7.2	Inspections during initial start-up .....	39			
<b>8.</b>	<b>Operation .....</b>	<b>40</b>			
8.1	General information .....	40			
<b>9.</b>	<b>Cleaning .....</b>	<b>41</b>			
9.1	Cleaning agents.....	41			
9.2	Exterior cleaning .....	41			
9.3	Interior cleaning.....	41			

## Explanation of symbols and signs

	General warning		Dangerous electrical voltage		Risk of falling		Hot surfaces
	Unintentional intake		Crushing hazard		Pressure injection		Suspended load
	Electrostatically sensitive components		Potentially explosive atmosphere		Wear personal protective equipment (gloves)		Wear personal protective equipment (protective clothes)
	Wear personal protective equipment (goggles)		Wear personal protective equipment (face shield)		General notes		Wear personal protective equipment (safety shoes)
	Release the product.		Disposal, recycling		Disposal of waste electrical and electronic equipment		Keep unauthorized persons away.
	CE marking						

	Warning level	Consequence	Probability	Symbol	Meaning
	<b>DANGER</b>	Death, serious injury	imminent	●	Chronological guidelines
	<b>WARNING</b>	Death, serious injury	possible	○	Lists
	<b>CAUTION</b>	Minor injury	possible	→	Indicates the prerequisites that have to be fulfilled for the activities described in the following
	<b>NOTICE</b>	Property damage	possible	☞	Refers to other facts, causes, or consequences

Abbreviations and conversion factors

re.	regarding	°C	degrees Celsius	°F	degrees Fahrenheit
approx.	approximately	K	Kelvin	Oz.	Ounce
i.e.	that is	N	Newton	fl. oz.	fluid ounce
etc.	et cetera	h	hour	in.	inch
poss.	possibly	s	second	psi	pounds per square inch
if appl.	if applicable	d	day	sq.in.	square inch
a.a.r.	as a rule	Nm	Newtonmeter	cu. in.	cubic inch
incl.	including	ml	millilitre	mph	miles per hour
min.	minimum	ml/d	millilitre per day	rpm	revolutions per minute
max.	maximum	cc	cubic centimetre	gal.	gallon
min.	minute	mm	millimetre	lb.	pound
etc.	et cetera	l	litre	hp	horse power
e.g.	for example	dB (A)	Sound pressure level	kp	kilopound
kW	kilowatt	>	greater than	fpsec	feet per second
U	Voltage	<	less than	Conversion factors	
R	resistance	±	plus/minus	Length	1 mm = 0.03937 in.
I	current	∅	diameter	Area	1 cm <sup>2</sup> = 0.155 sq.in
V	volt	kg	kilogram	Volume	1 ml = 0.0352 fl.oz.
W	watt	rh	relative humidity		1 l = 2.11416 pints (US)
AC	alternating current	≈	approximately	Mass	1 kg = 2.205 lbs
DC	direct current	=	equal to		1 g = 0.03527 oz.
A	ampere	%	per cent	Density	1 kg/cc = 8.3454 lb./gal(US)
Ah	Ampere hour	‰	per mille		1 kg/cc = 0.03613 lb./cu.in.
Hz	Frequency [Hertz]	≥	greater than	Force	1 N = 0.10197 kp
nc	normally closed contact	≤	less than	Pressure	1 bar = 14.5 psi
no	normally open contact	mm <sup>2</sup>	square millimetre	Temperature	°C = (°F-32) x 5/9
		rpm <sup>-1</sup>	revolutions per minute	Output	1 kW = 1.34109 hp
				Acceleration	1 m/s <sup>2</sup> = 3.28084 ft./s <sup>2</sup>
				Speed	1 m/s = 3.28084 fpsec.
					1 m/s = 2.23694 mph

# 1. Safety instructions

## 1.1 General safety instructions

- The owner must ensure that safety information has been read by any persons entrusted with works on the product or by those persons who supervise or instruct the before-mentioned group of persons. In addition, the owner must also ensure that the relevant personnel are fully familiar with and have understood the contents of the Instructions. It is prohibited to commission or operate the product prior to reading the Instructions.
- These Instructions must be kept for further use.
- The described products were manufactured according to the state of the art. Risks may, however, arise from a usage not according to the intended purpose and may result in harm to persons or damage to material assets.

- Any malfunctions which may affect safety must be remedied immediately. In addition to these Instructions, general statutory regulations for accident prevention and environmental protection must be observed.

## 1.2 General behaviour when handling the product

- The product may be used only in awareness of the potential dangers, in proper technical condition, and according to the information in these instructions.
- Familiarize yourself with the functions and operation of the product. The specified assembly and operating steps and their sequences must be observed.
- Any unclear points regarding proper condition or correct assembly/ operation must be clarified. Operation is prohibited until issues have been clarified.

- Keep unauthorized persons away.
- Wear personal protective equipment always.
- Precautionary operational measures and instructions for the respective work must be observed.
- Responsibilities for different activities must be clearly defined and observed. Uncertainty seriously endangers safety.
- Safety-related protective and emergency devices must not be removed, modified or affected otherwise in their function and are to be checked at regular intervals for completeness and function.
- If protective and safety equipment has to be dismantled, it must be reassembled immediately after finishing the work, and then be checked for correct function.



## 1. Safety instructions

- Remedy occurring faults in the frame of responsibilities. Immediately inform your superior in the case of faults beyond your competence.
- Never use parts of the centralized lubrication system or of the machine as standing or climbing aids.

### 1.3 Intended use

The pneumatically driven piston pump unit of the series PPS30 is for supplying MonoFlex centralized lubrication systems with lubricant and is intended for use in single-line centralized lubrication systems. It feeds fluid greases approved by SKF that are based on mineral oils as well as environmentally friendly and synthetic fluid greases of NLGI grades 00 to 000, as well as mineral, environmentally friendly, and synthetic oils with a permissible operating viscosity from 20 to 1500 mm<sup>2</sup>/s.

These must be compatible with plastic and NBR elastomers.

The use of synthetic and biodegradable fluid greases requires prior approval from SKF. Observe the information on permissible lubricants, Chapter 2.3.

The PPS30 piston pump unit has three lubricant outlets that can be used individually or collectively (note the total length of lines). The permissible operating temperature range of the PPS30 is 10 to 50°C.

The specifications in the “Technical data” chapter must be adhered to.

Only media approved for the PPS30 piston pump unit may be used.

Unsuitable media may result in malfunctions, failure of the unit, and potentially severe bodily injury or death and property damage.

Unless specially indicated otherwise, pneumatically driven piston pump units of the series PPS30 are not approved for use in potentially explosive areas as defined in the Directive ATEX-2014/34/EU.

The optional oil-filling strainer may be used with oil only in combination with the PPS30.

### 1.4 Foreseeable misuse

Any usage differing from the one stated in these Instructions is strictly prohibited, particularly a usage:

- outside the indicated temperature range
- with non-specified means of operation
- in continuous operation
- in areas with aggressive or corrosive materials (e.g. high ozone pollution)
- in areas with harmful radiation (e. g. ionising radiation)
- to supply, transport, or store hazardous substances and mixtures in accordance

with annex I part 2-5 of the CLP regulation (EC 1272/2008) and marked with GHS 01 - GHS 09 hazard pictograms.

- to feed, forward, or store gases, liquefied gases, dissolved gases, vapours, or fluids whose vapour pressure exceeds normal atmospheric pressure (1013 mbar) by more than 0.5 bar at the maximum permissible operating temperature.
- in an explosion protection zone

### 1.5 Painting of plastic parts

Painting of any plastic parts or seals of the described products is expressly prohibited.

Remove or completely tape parts concerned before painting the superior machine.

### 1.6 Modifications of the product

Unauthorized conversions or modifications may result in unforeseeable impacts on safety. Therefore, any unauthorized conversions or modifications are expressly prohibited.

### 1.7 Prohibition of certain activities

Due to potential sources of faults that may not be visible or due to legal regulations the following activities may be carried out by manufacturer specialists or authorized persons only:

- Repairs, changes to the drive
- Replacement of or changes to the pistons of the pump elements

### 1.8 Inspections prior to delivery

The following inspections were carried out prior to delivery:

- Safety and functional tests

## 1. Safety instructions

### 1.9 Other applicable documents

In addition to these instructions, the following documents must be observed by the respective target group:

- Operational instructions and approval rules
- Safety data sheet of the lubricant used

Where appropriate:

- Project planning documents
- Any documents of other components required to set up the centralized lubrication system
- Other relevant documents for the integration of the product into the machine or system

### 1.10 Information label on product

The following information label is affixed to the product. Before commissioning, check that the label is present and intact. Immediately replace the label if damaged or missing. The product must not be operated until then. See the positioning diagram for the ordering number and positions on the product.

#### NOTE

Fill only using suitable lubricants;  
– see instructions in Chapter 2.3,  
“Approved lubricants.”

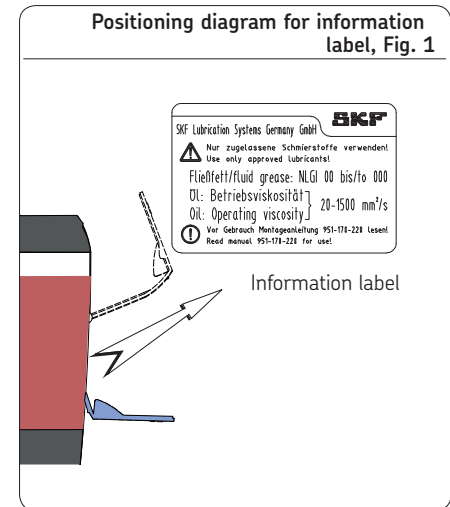

#### Spare parts kit

Containing a flap and information label  
Order No.: 995-901-060

### 1.11 Note on the rating plate

The rating plate provides important data such as the type designation, year/week of manufacture, Serial number and barcode. To avoid loss of this data in case the rating plate becomes illegible, these characteristics should be entered in the following table.

### 1.12 Notes related to the CE marking

CE marking is effected following the requirements of the applied directives:

- 2014/30/EU  
Electromagnetic compatibility

- 2011/65/EU  
(RoHS II) Directive on the restriction of the use of certain hazardous substances in electrical and electronic equipment

[Reference on Low Voltage Directive 2014/35/EU](#)

The protective regulations of Low Voltage Directive 2014/35/EU are fulfilled according to annex I (1.5.1) of Machinery Directive 2006/42/EC.

[Reference on Pressure Equipment Directive 2014/68/EU](#)

Because of its performance data the product does not achieve the limit values defined in Article 4 (1) (a) (i) and is therefore excluded from the scope of application of Pressure Equipment Directive 2014/68/EU following Article 4 (3).

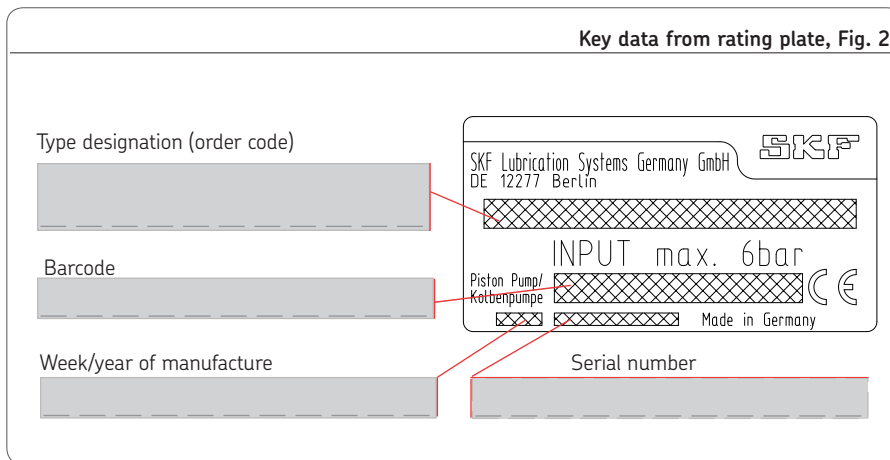

### 1.13 Persons authorized to operate the pump

#### 1.13.1 Operator

A person who is qualified by training, knowledge and experience to carry out the functions and activities related to normal operation. This includes avoiding possible hazards that may arise during operation.

#### 1.13.2 Specialist in mechanics

Person with appropriate professional education, knowledge and experience to detect and avoid the hazards that may arise during transport, installation, start-up, operation, maintenance, repair and disassembly.

#### 1.13.3 Specialist in electrics

Person with appropriate professional education, knowledge and experience to detect and avoid the hazards that may arise from electricity.

### 1.14 Briefing of external technicians

Prior to commencing the activities, external technicians must be informed by the operator of the company safety provisions, the applicable accident prevention regulations to be maintained, and the functions of the superordinate machine and its protective devices.

### 1.15 Provision of personal protective equipment

The operator must provide suitable personal protective equipment for the respective location of operation and the purpose of operation.

### 1.16 Operation

The following must be observed during commissioning and operation.

- Any information within this manual and the information within the referenced documents.
- All laws and regulations to be complied with by the user.

### 1.17 Emergency stopping of the pump station

In case of an emergency stop the pump station by:

- Switching off the superior machine or system in which the pump station has been integrated.
- Actuating the emergency stop switch of the superior machine.

### 1.18 Transport, installation, maintenance, malfunctions, repair, shutdown, disposal

- All relevant persons must be informed of the activity prior to starting any work. Observe the precautionary operational measures and work instructions.
- Carry out transport using suitable transport and hoisting equipment on suitable ways only.
- Maintenance and repair work can be subject to restrictions in low or high temperatures (e.g. changed flow properties of the lubricant). Therefore, where possible, try to carry out maintenance and repair work at room temperature.
- Prior to performing work, the product and the machine, into which the product will be integrated, must be depressurized and secured against unauthorized activation.
- Ensure through suitable measures that movable or detached parts are immobilized during the work and that no limbs can be caught in between by inadvertent movements.
- Assemble the product only outside of the operating range of moving parts, at an adequate distance from sources of heat or cold. Other units of the machine or vehicle must not be damaged or impaired in their function by the installation.
- Dry or cover wet, slippery surfaces accordingly.
- Cover hot or cold surfaces accordingly.
- Work on electrical components must be carried out by electrical specialists only. Observe any waiting periods for discharging, if necessary.
- Carry out electrical connections only according to the information in the valid wiring diagram and taking the relevant regulations and the local connection conditions into account.
- Do not touch cables or electrical components with wet or damp hands.
- Fuses must not be bypassed. Replace defective fuses always by fuses of the same type.
- Undertake drilling at non-critical, non-load bearing parts only. Use any available boreholes. Do not damage lines and cables when drilling.
- Observe possible abrasion points. Protect the parts accordingly.

- All components used must be designed for:
    - maximum operating pressure
    - maximum / minimum ambient temperature
  - No parts of the centralized lubrication system may be subjected to torsion, shear, or bending.
  - Check all parts prior to their usage for contamination and clean, if necessary.
  - Lubricant lines should be primed with lubricant prior to installation. This makes the subsequent ventilation of the system easier.
  - Observe the specified tightening torques. When tightening, use a calibrated torque wrench.
- 1.19 Initial commissioning / daily start-up**
- Ensure that:
- All safety devices are completely available and functional
  - All connections are correctly connected
  - All parts are correctly installed
  - All warning labels on the product are present completely, highly visible and undamaged
  - Illegible or missing warning labels are to be replaced without delay
- 1.20 Cleaning**
- Risk of fire and explosion when using inflammable cleaning agents. Only use non-flammable cleaning agents suitable for the purpose.
  - Do not use aggressive cleaning agents.
  - Do not use steam jet or high pressure cleaners. Electrical components may be damaged. Observe the IP protection class.
  - Cleaning work may not be carried out on energized components.
  - Mark damp areas accordingly.

### 1.21 Residual risks

Residual risk	Possible in life cycle	Prevention/ remedy
People slipping due to floor contamination with spilled/leaked lubricant	B	<ul style="list-style-type: none"> <li>• Exercise caution when connecting hydraulic connections on the product</li> <li>• Promptly apply suitable binding agents and remove the leaked/spilled lubricant</li> <li>• Follow operational instructions for handling lubricants and contaminated parts</li> </ul>
Tearing/damage to lines when installed on moving machine components	B	<ul style="list-style-type: none"> <li>• If possible, do not install on moving parts; if this cannot be avoided, use flexible hose lines</li> </ul>
Excessive system air pressure resulting in destruction of lubrication system components	B,C	<ul style="list-style-type: none"> <li>• Install a pressure reducer on the compressed air feed and set regulator to maximum pressure of 6 bar</li> </ul>
Lubricating oil spraying out due to faulty component fitting/line connection.	B,C	<ul style="list-style-type: none"> <li>• Tighten all components securely or using the specified torques. Use hydraulic connections and lines suitable for the indicated pressures. These must be checked for proper connection and for damage prior to commissioning</li> </ul>
People slipping due to floor contamination with spilled/leaked lubricant	C,E,G,H,K	<ul style="list-style-type: none"> <li>• Exercise caution when undoing or connecting the product's hydraulic connections</li> <li>• Promptly apply suitable binding agents and remove the leaked/spilled lubricant</li> <li>• Follow operational instructions for handling lubricants and contaminated parts</li> </ul>
Life cycle: A = transport, B = installation, C = initial start-up, D = operation, E = cleaning, F = maintenance, G = fault, repair, H = shutdown, K = disposal		



Residual risk	Possible in life cycle	Prevention/ remedy
Environmental contamination by lubricants and wetted parts	H,K	<ul style="list-style-type: none"><li>• Dispose of contaminated parts according to the applicable legal/company rules</li></ul>
Life cycle: A = transport, B = installation, C = initial start-up, D = operation, E = cleaning, F = maintenance, G = fault, repair, H = shutdown, K = disposal		

## 2. Lubricants

### 2.1 General information

Lubricants are used specifically for certain application purposes. In order to fulfil their tasks, lubricants must fulfil various requirements to varying extents. The most important requirements for lubricants are:

- Reduction of abrasion and wear
- Corrosion protection
- Noise minimisation
- protection against contamination or penetration of foreign objects
- Cooling (primarily with oils)
- longevity (physical/ chemical stability)
- compatibility with as large a number of materials as possible
- Economic and ecological aspects

### 2.2 Selection of lubricants

SKF considers lubricants to be an element of system design. A suitable lubricant is selected already when designing the machine and forms the basis for the planning of a centralized lubrication system.

The selection is made by the manufacturer/ operator of the machine, preferably together with the lubricant supplier based on the requirement profile defined.

Should you have little or no experience with the selection of lubricants for centralized lubrication systems, please contact SKF.

If required we will be glad to support customers to select suitable components for feeding the selected lubricant and to plan and design their centralized lubrication system.

You will avoid possible costly downtimes through damage to your machine/ system or damage to the centralized lubrication system.



Only lubricants specified for the product may be used. Unsuitable lubricants may lead to a failure of the product.



Do not mix lubricants. This may have unforeseeable effects on the usability and therefore on the function of the centralized lubrication system.



Due to the multitude of possible additives, it is possible that individual lubricants, which according to the manufacturer's data sheets fulfil the necessary specification, are not in fact suitable for use in centralized lubrication systems (e.g. incompatibility between synthetic lubricants and materials). In order to avoid this, always use lubricants tested by SKF.

### 2.3 Material compatibility

Lubricants must generally be compatible with the following materials:

- steel, grey iron, brass, copper, aluminium
- NBR, FPM, ABS, PA, PU

### 2.4 Ageing of lubricants

After a prolonged downtime of the machine, the lubricant must be inspected prior to re-commissioning as to whether it is still suitable for use due to chemical or physical ageing. We recommend that you undertake this inspection already after a machine downtime of 1 week.

If doubts arise as to the suitability of the lubricant, please replace it prior to re-commis-

sioning and, if necessary, undertake initial lubrication manually.

It is possible for lubricants to be tested in the company's laboratory for their suitability for being pumped in centralized lubrication systems (e.g. "bleeding").

Please contact SKF if you have further questions regarding lubricants.

You may request an overview of the lubricants tested by SKF.

### 3. Overview, functional description

Overview of PPS30 piston pump unit, Fig. 3

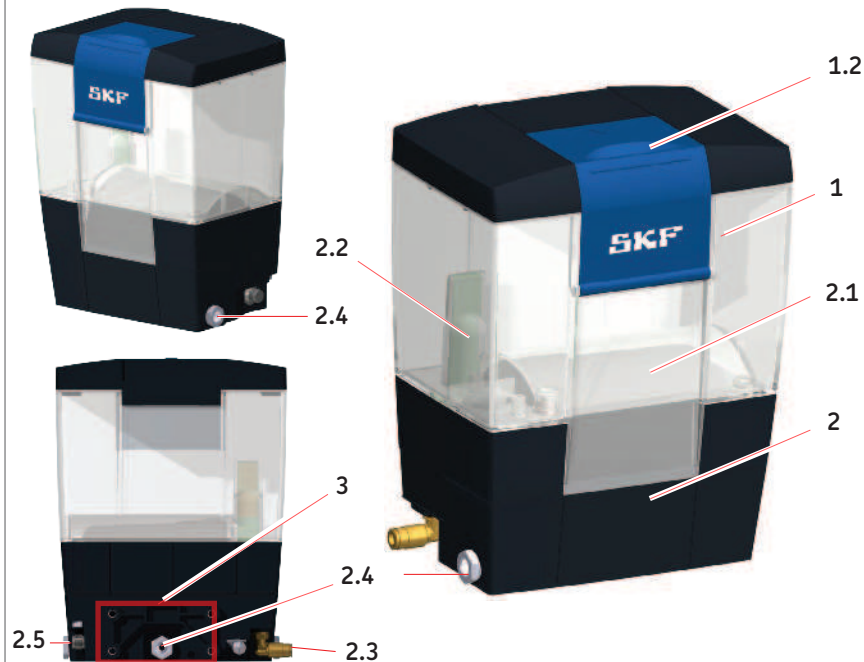

#### Item Description

PPS30 piston pump unit

#### 1 Reservoir

1.2 Filling flap

#### 2 Pump bottom, complete

2.1 Pneumatic piston pump

2.2 Fill level switch

2.3 Compressed air supply port

2.4 Lubrication line connections

2.5 Electr. signal port

#### 3 Installation surface with installation thread inserts M6

#### Note!

Note the length of the mounting screws! (see Fig. 12, Page 33)

3.1 Product codes

Product code

Right pump side  
Rear pump side  
Left pump side

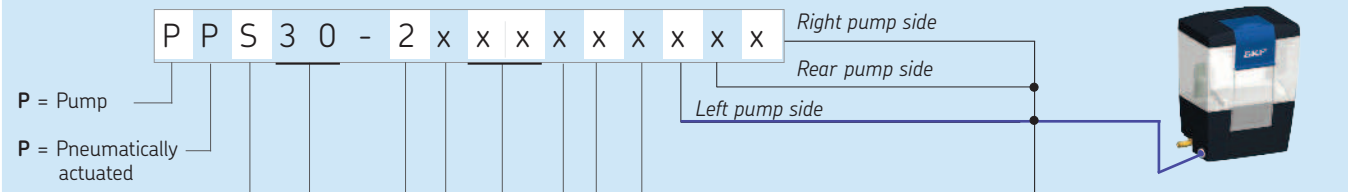

**P P S 3 0 - 2 x x x x x x x x x**

P = Pump  
P = Pneumatically actuated  
Lubricant S = Oils and fluid greases  
Delivery rate 30 = 30 cm<sup>3</sup>/stroke  
Generation 2 = 2 nd generation

Lubricant reservoir	
1	1.5 liters <sup>1)</sup>
2	1.5 liters with oil-filling strainer <sup>3)</sup>

Fill level switch min. (pre-warning)	
W 1	with switch <sup>1)</sup>
x x	without switch

Pneumatic connection	
1	Pipe thread M10x1
2	Plug connector Ø 6
3	Banjo fitting Ø 6 <sup>1)</sup>
4	Plug connector Ø 8

Electrical connection <sup>2)</sup>	
A	M12x1 plug, 4-pin <sup>1)</sup>
x	None

Pressure switch	
A	16 bar <sup>1)</sup>
x	None

Main line connection	
1	Pipe thread M10x1
2	Plug connector Ø 6 <sup>1)</sup>
3	Banjo fitting Ø 6
4	Plug connector Ø 8
x	Closed



<sup>1)</sup> = Ordering example: PPS30-21W1AA32xx  
<sup>2)</sup> = "x" is assigned automatically if fill level switch and pressure switch are absent.  
<sup>3)</sup> = The oil-filling strainer option can be used only with PPS30 pumps produced after September 29, 2017.

### 3.2 General information

☞ See Figure 4

The PPS30 piston pump unit **(1)** contains a pneumatic piston pump **(2)** with a pressure switch for system pressure monitoring, a fill level switch for “Pre-warning minimum fill level,” a pressure relief valve and a lubricant reservoir **(3)** with an effective volume of approx. 1.5 liters.

The housing and reservoir are made on plastic, providing reduced weight compared to conventional pump units.

Thanks to its compact design and easy installation, the PPS30 piston pump unit can be used to set up single-line centralized lubrication systems very easily and with little mounting effort.

The delivery rate of the piston on the PPS30 is up to 30 cm<sup>3</sup>/stroke.

However, when designing the system note that only approximately 70% of this value should be utilized as the metered quantity (see the design principles for single-line centralized lubrication systems).

### 3.3 Functional description of single-line systems

☞ See Figure 4

An inlet air pressure of 4.5 to a maximum of 6 bar is present at the 3/2 directional control valve **(4)**.

The pneumatic piston pump **(2)** in the pump unit is actuated once the machine control unit switches the directional solenoid valve to feed-through. This triggers a piston stroke/delivery stroke with constant lubricant delivery of up to 30 cm<sup>3</sup>/stroke.

The hydraulic system pressure is increased due to contact resistance within the pump unit.

The lubricant is then fed to the distributors **(5)** at a system pressure of approx. 20 to 30 bar depending on the inlet pressure.

An integrated pressure switch monitors the system pressure and transmits a signal to the machine control unit once system pressure rises to 16 bar.

The system pressure that has been built up meters the lubricant for each lubrication point via the downstream piston distributors **(5)**

and feeds it to the consuming points.

In prelubrication distributors, this occurs simultaneously with pressure build-up in the lubrication line; in relubrication distributors, this occurs following pressure relief. In a time slot specified by the machine control unit, the 3/2 directional solenoid valve **(4)** switches over (switch position “vent”), which turns off the pneumatic piston pump **(2)**.

The pressure relief valve in the piston pump unit is used to relieve the system pressure built up during a lubricating cycle to a residual pressure of approx. 0.5 bar once the pneumatic piston pump is turned off. This is required for the operation of the distributors.

Another signal is sent to the machine control unit by the fill level switch upon reaching the “minimum fill level” pre-warning. The signal serves as a pre-warning and allows for continued temporary operation until filling.

The filler socket on the reservoir is accessible via a forward-opening flap (6). It is opened by pulling forward over the upper recessed grip.

To simplify filling with fluid grease, the PPS30 is not equipped with a filler screen in the filler socket, though a strainer is integrated in the suction area of the pump. If this strainer becomes contaminated by impurities in the lubricant, the unit must be sent in to SKF. Therefore, fill using only clean, uncontaminated lubricants.

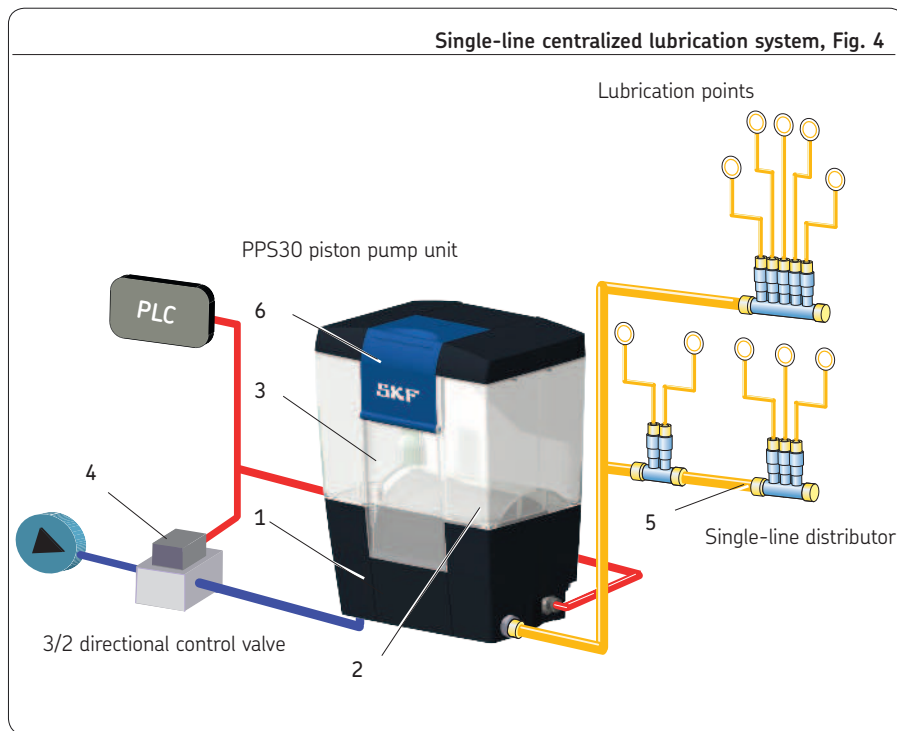

### 3.4 Functional description of the pneumatic piston pump

#### Time between 2 lubricating cycles

☞ See Figure 5

*The following requirements are met:*

- o No compressed air is applied to the PPS30
- o All lubricant lines are filled
- o The lubricant lines are relieved (relief pressure approx. 0.5 bar)
- o The actuating piston (1) is in its upper end position
- o The outlet valve (2) is closed

#### Start of lubricating cycle

☞ See Figure 6

The compressed air is activated by the control unit/the 3/2 directional control valve (**blue**) It flows into the chamber above the actuating piston (1) through the pump body (3) and the pressure cap (4) and presses the chamber downward. The actuating pressure closes the intake valve (5). The lubricant is expelled via the outlet valve (2) (**orange**). The single-line system is filled with the lubricant until pressure is equalized. The piston distributors expel the lubricant.

#### End of lubricating cycle

☞ See Figure 7

The compressed air is deactivated by the control unit/the 3/2 directional control valve and set to pressure relief. The actuating piston (1) is moved back to the upper end position by the pressure spring (6) During the return movement, the intake valve (5) is opened and lubricant is suctioned from the reservoir (7) and into the metering chamber of the pump body (8). At the same time, pressure in the lubricant lines is relieved. The lubricant is returned to the reservoir from the lubricant lines via the pressure relief valve (9). The pressure relief valve (9) closes at a residual pressure of approx. 0.5 bar in the lubricant lines. The piston distributors in the single-line system switch over and are ready for the next lubricating cycle.



Neutral position, Fig. 5

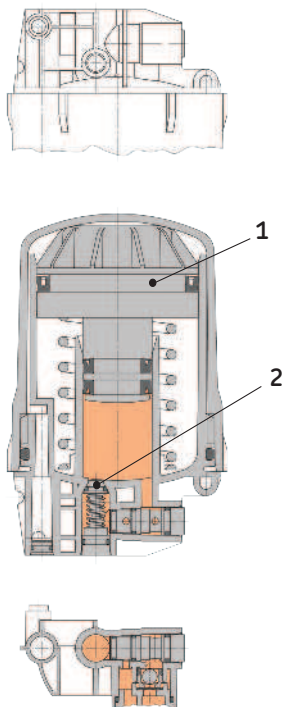

Start of lubricating cycle, Fig. 6

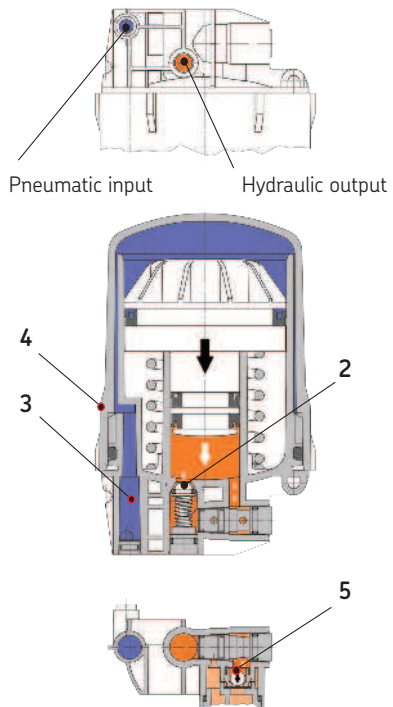

End of lubricating cycle, Fig. 7

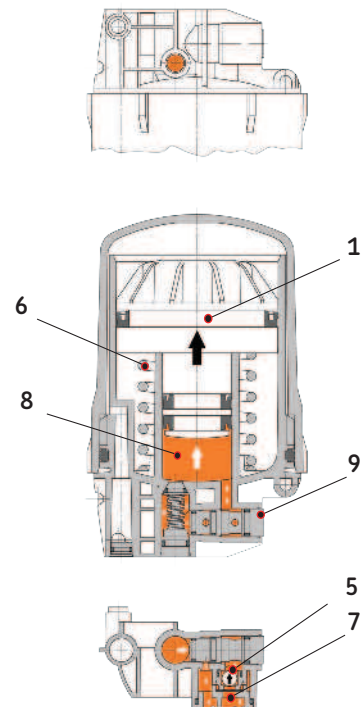

## 4. Technical data

### 4.1 General technical data

Mounting position:	Vertical
Ambient temperature:	+ 10 °C to + 50°C
Operating temperature:	+ 10 °C to + 50°C
Delivery rate:	Up to 30 cm <sup>3</sup> /stroke
Operating pressure:	Up to 26 bar - see Figure 8
Pumped medium <sup>1)</sup> :	Fluid greases of NLGI grades 00 to 000 with mineral oil, environmentally friendly, or synthetic base Mineral oil, environmentally friendly, and synthetic oils with permissible effective operating viscosity of 20 to 1500 mm <sup>2</sup>
Compatible with:	Plastics, NBR elastomers, copper, copper alloys
Purity of permissible compressed air:	At least quality class acc. to DIN ISO 8573-1: Max. particle size/density 40 µm/10 mg/m <sup>3</sup> ; pressure dew point 7°C; water content max. 7,800 mg/m <sup>3</sup> ; residual oil content max. 25 mg/m <sup>3</sup>
Purity level of permissible oils:	ISO 4066:1999 <= class 19/17/14 NAS 1638 <= class 8, recommended degree of filtration 5 to 10 µm
Effective volume:	Approx. 1.5 liters
Residual pressure of residual pressure valve	Approx. 0.5 bar
Max. permissible elevation difference on main line:	Approx. 5 m
Weight empty:	2150 g (with 3 screw unions and one banjo fitting order code PPS30-21W1AA3XXX)
<i>1) The lubricant must not impair the fill level monitoring function due to high adhesion and/or poor flow characteristics!</i>	

Maximum actuating frequency:	6 cycles/hour
Max. permissible loading by:	Shocks, half-sine acc. to IEC 60068-2-27 (15 g) Vibrations, sinusoidal acc. to IEC 60068-2-6 (2 g)
Protection class acc. to EN 60529	IP 54

<b>Pressure switch</b>	
Changeover pressure	16 ± 1 bar
Contact form	NO-contact
Switching voltage, max.	48 V DC
Switched current, max.	0,5 A

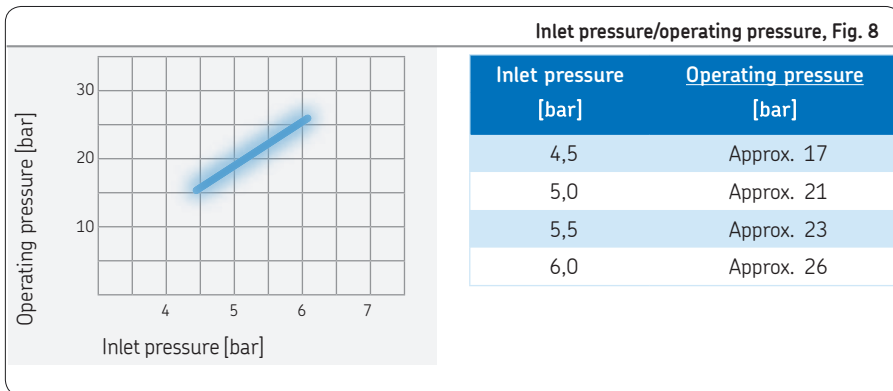

<b>Fill level switch</b>	
Contact form	PNP (NC)
Output current (typ.)	10 mA
Current limit (typ.)	20 mA (short-circuit-proof)
Switching capacity, max	0,6 W
Switching voltage, max.	10 to 32 V

## 5. Delivery, returns, and storage

### 5.1 Delivery

After receipt of the shipment, check the shipment for damage and completeness according to the shipping documents. Immediately report any transport damages to the forwarding agent.

Keep the packaging material until any discrepancies are resolved. During in-house transport ensure safe handling.

### 5.2 Returns

Clean all parts and pack them properly (i.e. following the regulations of the recipient country) before returning them.

Protect the product against mechanical influences such as impacts. There are no restrictions for land, sea or air transport.

Mark returns on the packaging as follows.



### 5.3 Storage



Before application inspect the products with regard to possible damages occurred during their storage. This particularly applies for parts made out of plastic and rubber (embrittlement) as well as for components primed with lubricant (ageing).

SKF products are subject to the following storage conditions:

- the admissible storage temperature range corresponds to that of the operating temperature (see Technical data)
- dry, dust- and vibration-free in closed premises
- no corrosive, aggressive materials at the place of storage (e. g. UV rays, ozone)
- protected against pests and animals
- in the original product packaging
- shielded from nearby sources of heat and coldness
- in case of high temperature fluctuations or high humidity take adequate measures (e. g. heater) to prevent the formation of condensation water.

## 6. Assembly

### 6.1 General information

Only qualified technical personnel may install, operate, maintain, and repair the PPS30 pneumatically driven piston pump unit.

Qualified technical personnel are persons who have been trained, assigned, and instructed by the operator of the final product into which the piston pump unit described here is incorporated.

Such persons are familiar with the relevant standards, rules, accident prevention regulations, and operating conditions as a result of their training, experience, and instruction. They are qualified to carry out the required activities and in doing so recognize and avoid potential hazards.

The definition of qualified personnel and the prohibition against employing non-qualified personnel are laid down in DIN VDE 0105 and IEC 364.

Before assembling/setting up the product, the packaging material and any shipping braces (e.g., plugs) must be removed.

The packaging material must be preserved until any discrepancies are resolved.

#### NOTE

Observe the technical data (Chapter 4).

### 6.2 Setup and attachment

The product should be protected from humidity and vibration, and should be mounted so that it is easily accessible, allowing all further installation work to be done without difficulty and the piston pump unit can be filled easily later.

The fill level of the reservoir must be clearly visible.

The unit is mounted in a vertical position. Assembly holes must be made according to the Figure 12 below.

Design specifications and conditions of the manufacturer and the object must be observed when installing the piston pump unit.

For the maximum permissible ambient temperature, see “Technical data.”

During assembly, always pay attention to the following:

- o Existing supply lines must not be damaged by assembly work.
- o Other units must not be damaged by assembly work.
- o The product must not be installed within range of moving parts.
- o The product must be installed at an adequate distance from sources of heat.

- o Maintain safety clearances and comply with local regulations for assembly and accident prevention.
- o Observe the maximum engagement length of the mounting screws (14 to 19 mm) (see Fig. 12).

	<b>WARNING</b>
	<p><b>Supply lines or moving parts</b></p> <p>When drilling the assembly holes, you must be careful of any supply lines or other units, as well as of other hazards such as moving components.</p> <p>Maintain safety clearances and comply with local regulations for assembly and accident prevention.</p>

	<b>WARNING</b>
	<p><b>Personal injury / property damage</b></p> <p>Drill assembly holes in such a way that no lines, units, or moving parts are damaged or their function impaired. Maintain safety clearances and comply with regulations for assembly and accident prevention.</p>

### 6.2.1 Minimum mounting dimensions

To ensure enough space for maintenance work and possible disassembly of the product, ensure that the minimum mounting dimensions (Fig. 10) are maintained.

### 6.2.2 Hydraulic layout

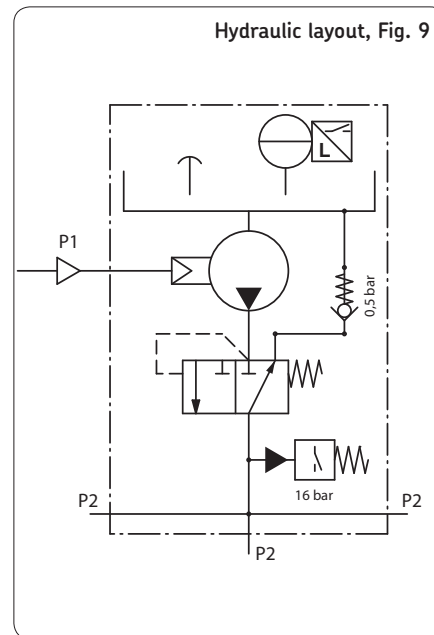

## 6.3 Port dimensions, assembly holes, and minimum mounting dimensions

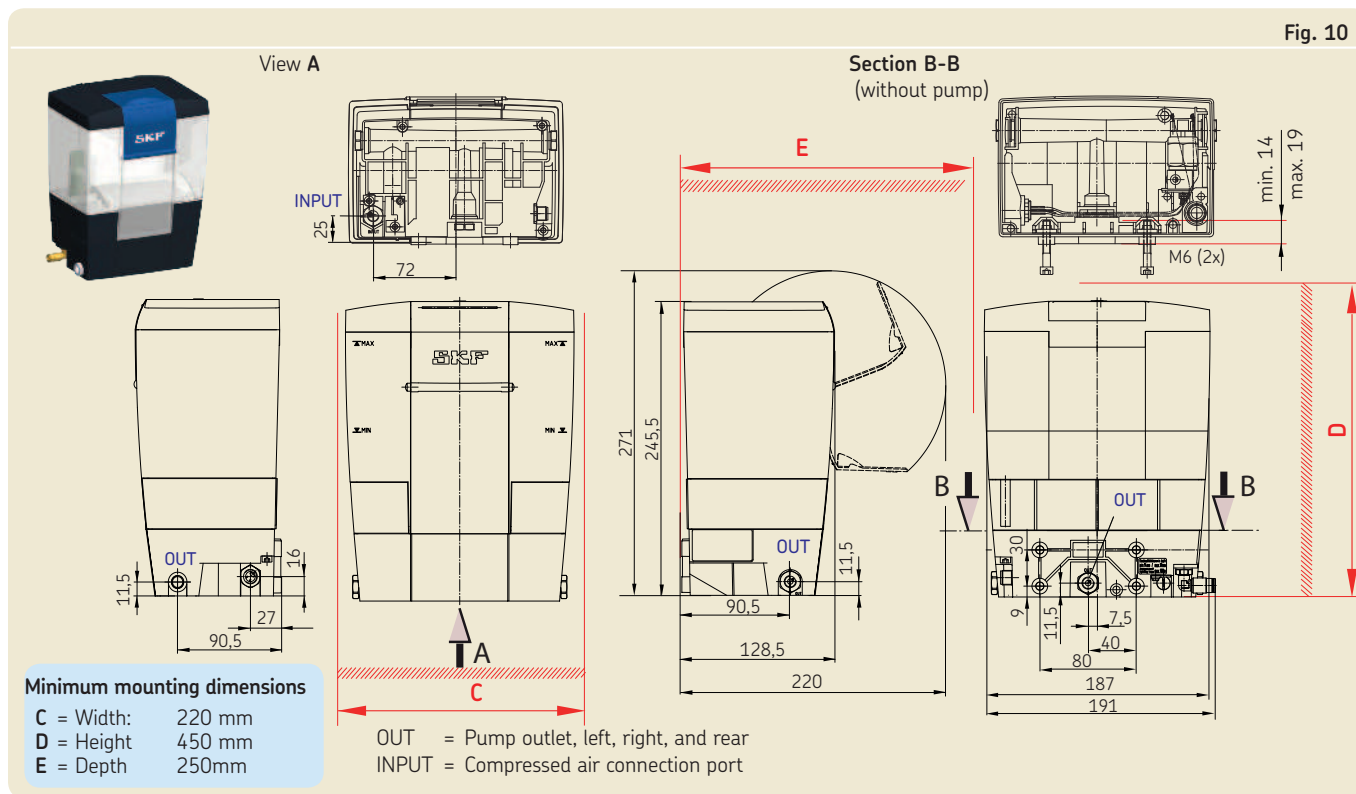

## 6.4 Assembly of the product

☞ See Figure 11

- Transport locking (1) -remove the Hexagon socket screws 2x, M6x18

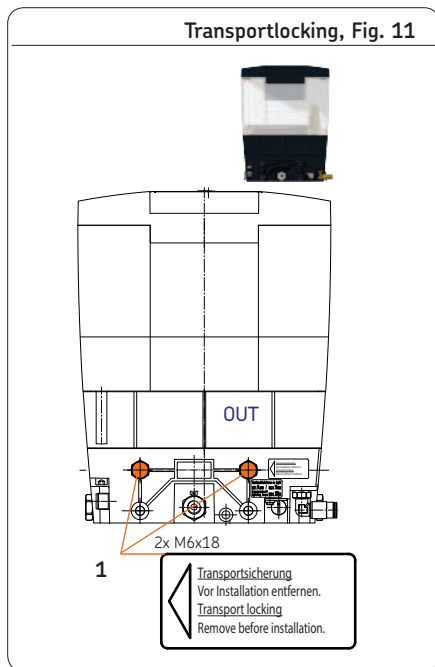

The PPS30 pneumatic piston pump unit is installed using 4 screws and 4 washers.

### NOTE

The minimum engagement depth of the mounting screws is 14 mm and the maximum engagement depth is 19 mm. These The engagement depths must not be above or below these values. The customer must determine the total length of the mounting screws according to the particular installation conditions.

Recommended fastening hardware:

- o Hexagon socket screws (4x) acc. to DIN EN ISO 4762-M6x...-8.8
- o Washers (4x) acc to. DIN EN ISO 7090-6-200HV

- Drill assembly holes (recommended diameter 6.5 mm) on the customer-provided mounting surface according to the assembly drawing (Figs. 10 and 12) as well as the conditions on the surface.
- Clean surface to remove drilling chips.
- Place the piston pump unit on the surface and roughly align it.
- Pass hexagon socket screws (4x) acc. to DIN EN ISO 4762-M6x...-8.8 with associated washers (4x) acc. to





**NOTE**

If installing a compressed air hose with plug connector, see the installation instructions in Chapter 6.7.

**Compressed air requirements, Table 1**

Requirement	Values
Inlet pressure	Min. 4.5 bar
Continuous operating pressure	max. 6 bar
Max. pressure peak <sup>1)</sup>	7 bar
Required airflow per stroke	Approx. 0.2 l
<b>Based on compressed air quality classes per DIN ISO 8573-1</b>	
Particle content:	Class 5
Maximum particle size	40 µm
Maximum particle content	10 mg/m <sup>3</sup>
Pressure dew point	Maximum: +7°C
Oil concentration	Maximum: 25 mg/m <sup>3</sup>
Residual water	Maximum: 7.8 g/m <sup>3</sup>

1) In brief and isolated cases

**If plug connectors are not pre-assembled:**

- Mount plug connector (1) for compressed air hose to the compressed air input port to the bottom side (M10x1). Ensure correct positioning of the plug connector.



**Tightening torque  $3 \pm 0.5$  Nm**

☞ Do not cause any kinks in the compressed air hose during the following installation. Avoid tight radiuses.

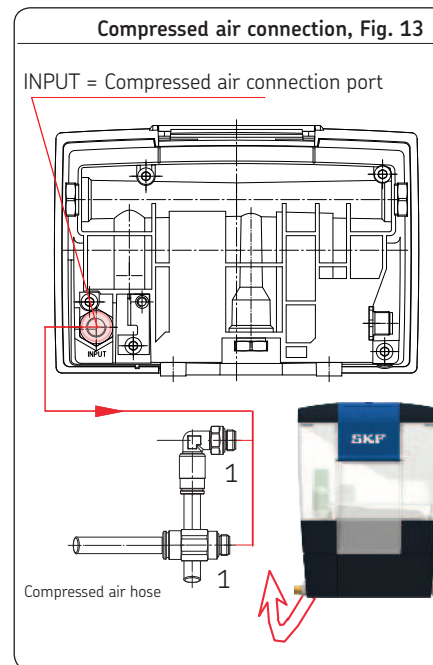
- Insert compressed air hose into plug connector - see chapter 6.7- and check for correctly seated.
- Route the compressed air hose in such way that it does not touch moving parts.



## 6.6 Lubrication line connection

	 <b>CAUTION</b>
	<p><b>Slipping hazard</b> Leaking lubricant is hazardous due to the risk of slipping and injury. Leaks must be sealed off without delay and in accordance with corporate rules and legal requirements.</p>

### NOTE

When mounting the hydraulic connection elements (e.g. plug connectors) the respective lubrication line connector (see Fig. 3, item 2.4) on the pump must be held on its external hex with a fork wrench (SW 17).

The lubrication line must be connected to the lubrication unit in such a way that no forces can be transferred to the assembled lubrication unit (stress-free connection)

The lubrication line must be connected to the lubrication unit in such a way that no forces can be transferred to the assembled lubrication unit (stress-free connection).

Lubricant lines made of transparent plastic are recommended so that the lubricant transport can be assessed visually. Lubricant lines made of transparent plastic are available in rigid (unplasticized) and flexible (plasticized) designs - see the Accessories chapter.

#### The following applies in general:

- o The pipes, hoses, shutoff valves, directional control valves, fittings, etc. that will be used must be designed for the maximum operating pressure of the lubrication unit, the permissible temperatures, and the lubricants that will be delivered.
- o All components of the lubrication line system such as pipes, hoses, shutoff valves, directional control valves, fittings,

etc. must be carefully cleaned before assembly.

- o No seals in the lubrication line system should protrude inwards in a way that disrupts the flow of the lubricant and could allow contaminants to enter the lubrication line system.
- o Lubrication lines should always be arranged so that air pockets cannot form anywhere.
- o Avoid changes in the cross-section of the lubrication line from small to large cross-sections in the direction of flow of the lubricant.
- o When the cross-section does change, the transition should be gentle.
- o The flow of lubricant in the lubrication lines should not be hindered by the installation of sharp bends, angle valves, or flap valves.
- o Unavoidable changes in the cross-section in lubrication lines must have smooth transitions. Sudden changes of direction should be avoided if possible.

## 6.7 Assembly of the lubrication lines using SKF plug connectors

The SKF plug connectors are available in designs for metal or plastic pipes. With the design for metal pipes, there is a choice available between pipe versions with and without claw groove.

The claw groove securely fastens the pipe in the plug connector, which prevents the metal pipe from slipping out of the plug connector. The claw groove does not need to be used if appropriate fastening hardware (e.g., mounting clips) is used to prevent the metal pipe from slipping out of the plug connector.

Both designs, for metal and plastic pipes, have a locking claw. The locking claw of the collet secures the pipe in the plug connector, which prevents the pipe from accidentally slipping out, at least in the case of the design for plastic pipe.

- Cut the connecting pipe **(1)** to the correct length with a pipe cutter
- ☞ In the following installation of the pipe, a noticeable resistance must be overcome when passing through the first O-ring **(2)**, the locking claw **(5)** of the collet **(4)**. If a claw groove is not used, fix the pipe using appropriate fastening hardware (e.g., mounting clips) to prevent the pipe from slipping out of the SKF plug connector.
- Manually insert the pipe **(1)** fully into the collet **(4)** of the SKF plug connector until it clears the first O-ring **(2)** and the locking claw **(5)** of the collet **(4)** and reaches the mechanical stop **(3)**.
- ☞ To remove the metal pipe **(1)**, press the collet **(4)** inward into the SKF plug

connector. The metal pipe **(1)** can now be pulled out of the collet **(4)** of the SKF plug connector.

To remove the plastic pipe **(1)**, press the collet **(4)** inward into the SKF plug connector. To do this, also press the plastic pipe **(1)** inward into the SKF plug connector fitting, which releases the collet **(4)** from the plastic pipe **(1)**. The plastic pipe **(1)** can now be pulled out of the collet **(4)** of the SKF plug connector.

Before reassembling, shorten the end of the plastic pipe by at least 7 mm to ensure that the locking claw **(5)** of the collet **(4)** functions properly.

6.8 Connection of electrical pressure switch and fill level switch

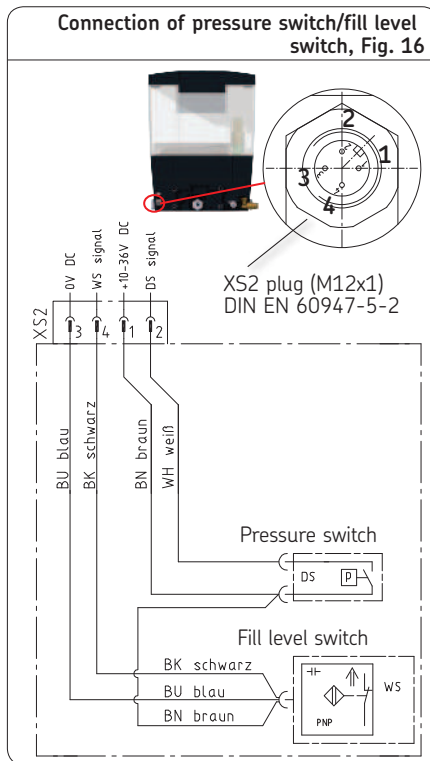
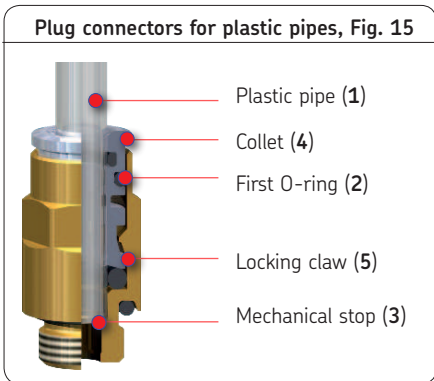
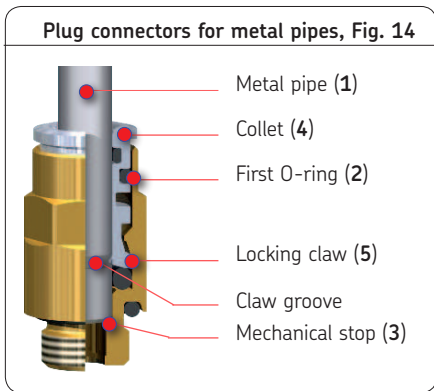

**Legend to Figure 16**

Code	Conductor coloring
BU	Blue
BK	Black
BN	Brown
WH	White

Pin	Assignment
<i>Pressure switch</i>	
1	Voltage + 10-36 V DC
2	Pressure switch signal (DS)
<i>Fill level switch</i>	
3	0V voltage 0V DC
4	"Pre-warning min. fill level" signal

## 6.9 Venting the centralized lubrication system

The process of venting the centralized lubrication system can be facilitated by:

- o Filling long tubing sections before connecting to the lubrication point.
- o Opening the ends of the main pipes (1) until bubble-free lubricant discharges from the ends.

### Requirement

- The PPS30 piston pump unit (2) must already be installed as described in this chapter and the compressed air line and lubricant line must be installed as well.
- Fill PPS30 piston pump unit with lubricant to “MAX” mark (4) via the filling flap (3).
- Remove lubricant lines at the inlet to the first distributor (5).
- Cycle PPS30 piston pump unit (2) until bubble-free lubricant discharges at the first distributor

- Mount the lubrication line
- Repeat the venting procedure at the following distributors
- Allow PPS30 piston pump unit (2) to run until lubricant can be seen discharging at all lubrication points.

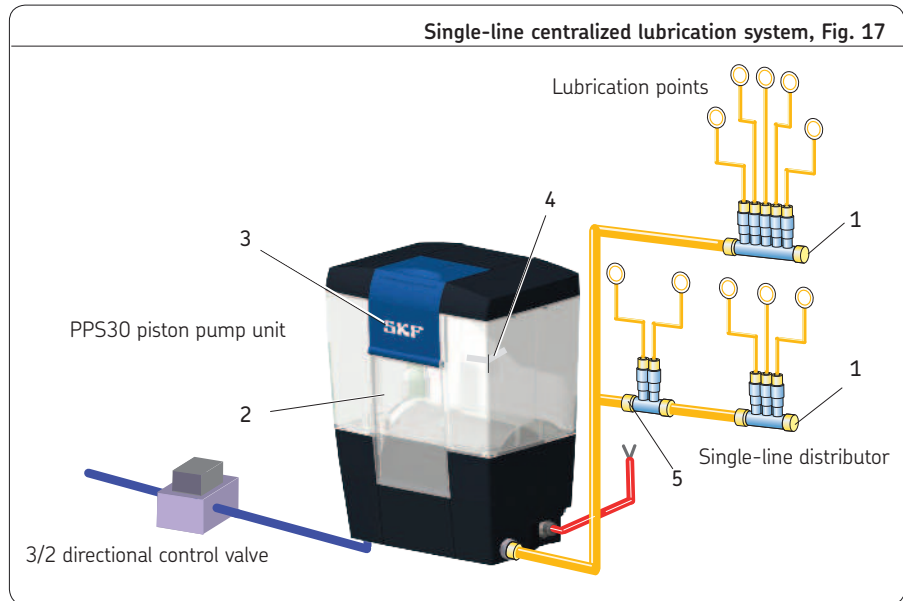

## 7. Initial start-up

### NOTE

#### Hazard due to excessively low or no lubricant

Check the fill level. The lubricant may only be fed without bubbles

Inspect all electrical and hydraulic connections before commissioning the piston pump unit.

The lubricant may only be fed without bubbles. The lubricant reservoir must be filled with clean lubricant without introducing bubbles.

- Fill the lubricant reservoir only using clean lubricant and an appropriate device.

If air is present in the lubrication system due to a possible leak, remedy it immediately and then vent the centralized lubrication system - see assembly instructions, Chapter 6.9.

In order to warrant safety and function, a person assigned by the operator must carry out the following inspections. Immediately eliminate detected deficiencies. Deficiencies may be remedied by an authorized and qualified specialist only.

#### Start-up check list

7.1 Inspections prior to initial start-up	YES	NO
Electrical connection carried out correctly.	<input type="checkbox"/>	<input type="checkbox"/>
Mechanical connections carried out correctly	<input type="checkbox"/>	<input type="checkbox"/>
Pneumatic connections carried out correctly.	<input type="checkbox"/>	<input type="checkbox"/>
The performance data of the previously indicated connections correspond to the specifications stated in the Technical data	<input type="checkbox"/>	<input type="checkbox"/>
All components, such as lubrication lines and metering devices, have been correctly installed	<input type="checkbox"/>	<input type="checkbox"/>
No visible damage, contamination and corrosion	<input type="checkbox"/>	<input type="checkbox"/>
Any dismantled protection and monitoring equipment has been reassembled and checked for correct function	<input type="checkbox"/>	<input type="checkbox"/>
7.2 Inspections during initial start-up		
No unusual noises, vibrations, accumulation of moisture, or odours present	<input type="checkbox"/>	<input type="checkbox"/>
No unwanted escape of lubricant from connections (leakages).	<input type="checkbox"/>	<input type="checkbox"/>
Lubricant is supplied free from bubbles	<input type="checkbox"/>	<input type="checkbox"/>
Bearings and friction points are provided with the planned amount of lubricant	<input type="checkbox"/>	<input type="checkbox"/>

## 8. Operation

### 8.1 General information

The products described here function automatically. The lubricant transport in the lubrication lines should, however, be subjected to regular visual inspection.

The lubricant fill level in the lubricant reservoir should be subjected to visual inspection on a regular basis.

Top up the lubricant if the fill level is too low

#### NOTE

Only fill using clean lubricant and an appropriate device. Contaminated lubricants lead to system malfunctions. The customer's lubricant reservoir must be filled without introducing bubbles.

#### NOTE

##### **Hazard due to excessively low or no lubricant**

Check the fill level. The lubricant may only be fed without bubbles

#### NOTE

Observe the instructions from the machine manufacturer regarding the lubricants that are to be used.

#### NOTE

##### **Property damage due to mixing of different lubricants**

It is recommended that an indication of the lubricant in use be attached to the lubricant reservoir in order to prevent accidental mixing of lubricants.



## 9. Cleaning



### WARNING



#### Compressed air

The product described here is pressurized during operation. The product must therefore be depressurized before starting the de-commissioning procedure.



#### Electric shock

Carry out cleaning works only on depressurized products that have been disconnected from the power supply. Do not touch cables or electrical components with wet or damp hands.

Use steam-jet cleaners or high-pressure cleaners only in accordance with the IP protection class of the pump. Otherwise electrical components may be damaged.

### 9.1 Cleaning agents

Cleaning agents compatible with the material may be used only (materials, see chapter 2.3).



Thoroughly remove residues of cleaning agents from the product and rinse off with clear water. Thus the formation of lye stone is avoided.

### 9.2 Exterior cleaning

- Mark and secure wet areas.
- Keep unauthorized persons away.
- Thorough cleaning of all outer surfaces with a damp cloth.



Make sure to keep the reservoir closed during the cleaning procedure.

### 9.3 Interior cleaning

Normally, interior cleaning is not required.

Should incorrect or contaminated lubricant have been filled, inside cleaning of the product will be required.

To do so, contact the SKF Customer Service.

## 10. Maintenance

Regular and appropriate maintenance is a prerequisite to detect and clear faults in time.

The specific timelines have to be determined, verified at regular intervals and adapted, if necessary, by the operator based on the operating conditions.

### NOTE



Dismantling of the product or individual parts thereof within the statutory warranty period is prohibited and voids any claims.

### NOTE

Only fill with clean grease. The purity of the lubricants used is the decisive factor in the service life of the pump and the lubricated machinery elements.

SKF shall not be held liable for damages resulting from improperly performed assembly, maintenance, or repair work on the product.

### 10.1 Maintenance schedule

		<b>WARNING</b>
<p><b>Compressed air</b> The product described here is pressurized during operation. The product must therefore be depressurized before starting assembly, maintenance or repair work, or any system modifications or system repairs.</p>		

#### Maintenance work

Maintenance work	Time period
<ul style="list-style-type: none"> <li>• Visually inspect the lubricant fill level</li> </ul>	Depending on pump cycles and system configuration
<ul style="list-style-type: none"> <li>• Regularly inspect system components for leaks</li> </ul>	During each filling
<ul style="list-style-type: none"> <li>• Inspect electrical cables for damage</li> </ul>	Annually
<ul style="list-style-type: none"> <li>• Visually inspect lubrication of bearings</li> </ul>	Annually

## 11. Troubleshooting

The following tables provide an overview of possible malfunctions and their causes. Contact the SKF Service department if you cannot remedy the malfunction.

### NOTE



Dismantling of the product or individual parts thereof within the statutory warranty period is prohibited and voids any claims.

### NOTE

All assembly, maintenance, and repair work beyond this scope must be performed by SKF's service department.

### NOTE

Only original SKF spare parts may be used. Unauthorized alterations to products and the use of non-original spare parts and accessories are prohibited.





		<b>WARNING</b>
		<p><b>Compressed air</b></p> <p>The product described here is pressurized during operation. The product must therefore be de-pressurized before starting repair work, system modifications, or system repairs.</p>

### 11.1 Commissioning, product, and system malfunctions

Malfunction	Cause	Remedy
Pneumatic piston pump fails to start when pneumatic valve is actuated	- 3/2 directional control valve is not switching to feed-through	<ul style="list-style-type: none"> <li>• Check inlet pressure; 4.5 to max. 6 bar required</li> <li>• Check electrical connection (plug) on valve</li> <li>• Check operating voltage on plug, replace plug if necessary</li> <li>• Inspect 3/2 directional control valve, replace valve if necessary</li> </ul>
Pneumatic piston pump is jammed	<ul style="list-style-type: none"> <li>- Pressure not relieved in advance</li> <li>- Piston blocked by resistance or defective stopper</li> <li>- Unsuitable lubricant (see Technical data)</li> </ul>	<ul style="list-style-type: none"> <li>• Check system pressure</li> <li>• Inspect 3/2 directional control valve, replace valve if necessary</li> <li>• Check whether distributor is jammed</li> <li>• Check pressure relief valve for correct cracking pressure and for contamination or damage (install pressure gauge between pump outlet and main lubricant line to do so)</li> <li>• If resistance is high, replace the PPS30 unit</li> <li>• Remove lubricant from entire system and dispose of lubricant properly; fill system with suitable lubricant</li> </ul>

Malfunction	Cause	Remedy
Pneumatic piston pump runs with difficult, builds up no pressure or does so very slowly	<ul style="list-style-type: none"> <li>- System pressure too low,</li> <li>- Screw union of pneumatic feed line is defective</li> <li>- Unsuitable lubricant (see Technical data)</li> </ul>	<ul style="list-style-type: none"> <li>• Check inlet pressure; 4.5 to 6 bar required</li> <li>• Tighten screw union, replace stopper if necessary</li> <li>• Remove lubricant from entire system and dispose of lubricant in the proper manner; fill system with suitable lubricant.</li> <li>• Replace unit</li> </ul>
No pressure relief	<ul style="list-style-type: none"> <li>- Unsuitable lubricant (see Technical data)</li> <li>- 3/2 directional control valve does not switch</li> <li>- Pressure relief valve is jammed or defective</li> </ul>	<ul style="list-style-type: none"> <li>• Remove lubricant from entire system and dispose of lubricant in the proper manner; fill system with suitable lubricant.</li> <li>• Inspect 3/2 directional control valve, replace solenoid valve if necessary</li> <li>• Replace unit</li> </ul>
No pressure build up in the main line	- Air in the main line	• Vent main line
	- Main line leaky/broken	• Repair main line
	- Pump defective	• Replace unit
	- Intake screen very contaminated	• Replace unit

## 12. Repairs

 <b>WARNING</b>
 <b>Risk of injury</b> Before carrying out any repair work, take at least the following safety measures:
 <ul style="list-style-type: none"> <li>○ Keep unauthorized persons away.</li> </ul>
 <ul style="list-style-type: none"> <li>○ Mark and secure work area.</li> <li>○ Depressurize the product.</li> <li>○ Disconnect the product from the power supply and secure it against being switched on.</li> <li>○ Verify that no power is being applied</li> <li>○ Where needed, cover neighbouring units that are live.</li> </ul>

## 13. Shutdown and disposal

### 13.1 Temporary shutdown

Temporarily shut the system down by:

- switching off the superior machine.
- Separation of the pneumatic Supply connection
- Disconnecting the product from the power supply.

### 13.2 Final shutdown and disassembly

The final shutdown and disassembly of the product must be professionally planned and carried out by the operator in compliance with all regulations to be observed.

### 13.3 Disposal

#### Countries within the European Union

Disposal should be avoided or minimized wherever possible. Disposal of products contaminated with lubricant must be effected via

a licensed waste disposal contractor in accordance with environmental requirements and waste disposal regulations as well as local authority requirements.



The specific classification of the waste is in the waste producer's responsibility, as the European Waste Catalogue provides different waste disposal codes for the same type of waste but of different origin.

Dispose of or recycle electrical components following WEEE directive 2012/19/EU.



Parts made of plastic or metal can be disposed of with the commercial waste.



#### Countries outside the European Union

The disposal has to be done according to the valid national regulations and laws of the country where the product is used.

## 14. Spare parts

Sealing flap, see Fig. 18

Item.	Designation	Weight [g/pc.]	Order No.
1	Flap and information label spare kit	30	995-901-060

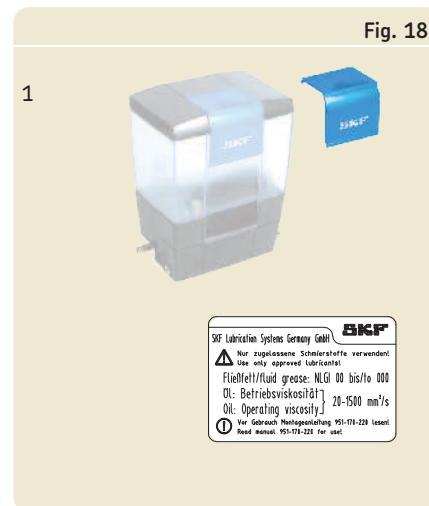

## 15. Accessories

Connections, Fig. 19

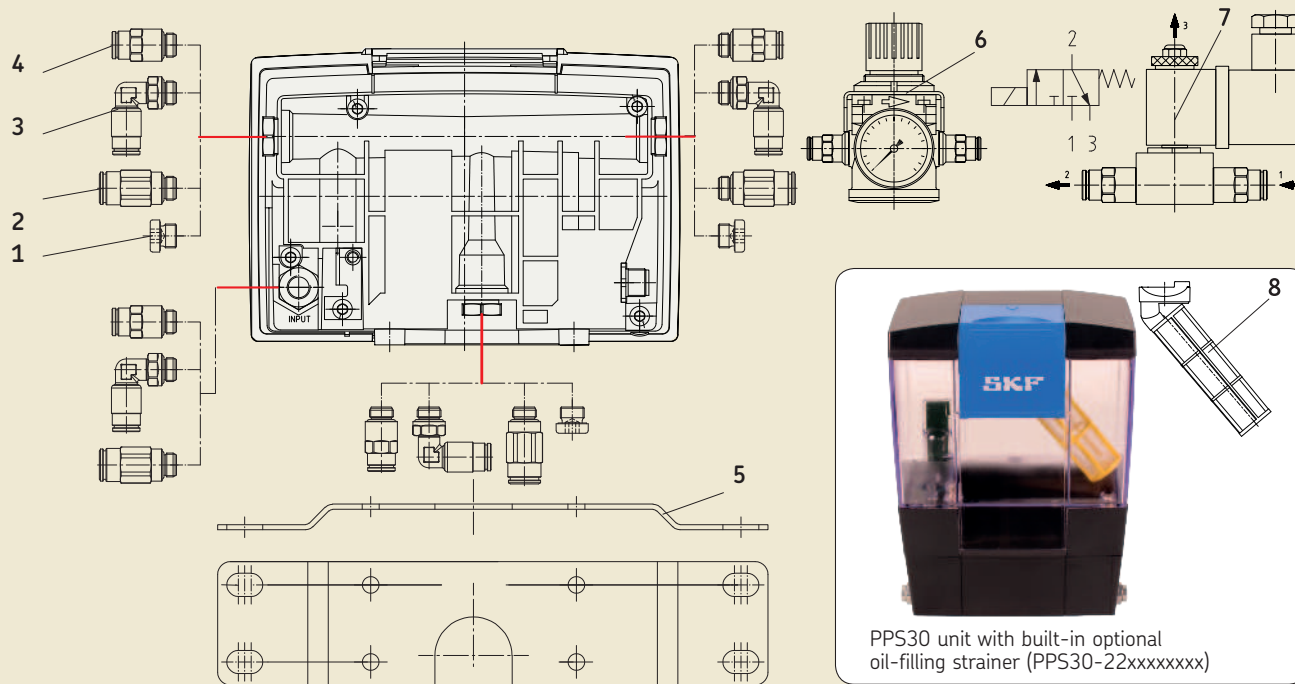



see Fig. 19

Item.	Designation	Weight [g/pc.]	Order No.
1	Screw plug with washer <sup>1)</sup>	7	466-431-001
2	Plug connector adapter for hose diameter 8 mm <sup>1)</sup>	20	408-004-VS
3	Plug connector banjo fitting hose diameter 6 mm <sup>1)</sup>	23	506-140-VS
4	Plug connector adapter for hose diameter 6 mm <sup>1)</sup>	15	406-004-VS
5	Wall bracket (with mounting hardware) <sup>2)</sup>	160	995-901-061
6	Control valve (kit) <sup>1)</sup>	460	995-901-062
7	3/2 directional control valve (kit) <sup>1)</sup>	180	995-901-063
8	Oil-filling strainer <sup>3)</sup>	16	169-400-405

1) Maximum tightening torque 3.5 Nm

2) Maximum tightening torque 6 Nm

3) The oil-filling strainer option can be used only with PPS30 pumps produced after September 29, 2017.

## Other accessories

Designation	Order No.
<b><u>Plastic tubing, unplasticized</u></b>	
Ø 6 mm	WVN715-R06×1.25 <sup>1)</sup>
Ø 8 mm	WVN715-R08×1.25 <sup>1)</sup>
<b><u>Plastic tubing, flexible (plasticized)</u></b>	
Ø 6 mm	WVN716-R06×1.25 <sup>1)</sup>
Ø 8 mm	WVN716-R08×1.2 <sup>1)</sup>
<b><u>Cable socket for electrical connection (M12x1)</u></b>	
Cable socket M12x1, straight	179-990-371
Cable socket M12x1, straight with cable 5 m	179-990-600

1) Add the desired length, e.g. 30 meters, to the order No.

Order example: WVN716-R06×1.25×30M

**Note!**

You can find additional technical data in the brochures:

Electrical Plug and Socket Connectors Brochure 1-1730-EN

Lubricant distributors for SKF MonoFlex systems Brochure 1-5001-EN

Transport of Lubricants in Centralized Lubrication Systems Brochure 1-9201-EN

Brochure 1-9201-EN

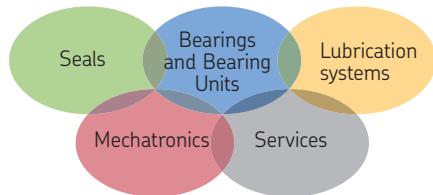

### **The Power of Knowledge Engineering**

Over the course of more than a century, SKF has specialized in five fields of competence and acquired a wide range of application expertise. We utilize this experience to provide innovative solutions to OEMs and other manufacturers in practically all industrial sectors worldwide. Our five fields of competence are: bearings and bearing units, seals, mechatronics (combining mechanical and electronic components to improve the performance of classic systems), and extensive services from 3-D computer simulations and modern condition monitoring systems for high reliability to system management. SKF is a leading global company and guarantees its customers uniform quality standards and global product availability.

**951-170-220-EN**

January 2018

Version 06

#### **SKF Lubrication Systems Germany GmbH**

Motzener Strasse 35/37 · 12277 Berlin · Germany

PO Box 70444 · 12704 Berlin · Germany

Tel. +49 (0)30 72002-0

Fax +49 (0)30 72002-111

[www.skf.com/lubrication](http://www.skf.com/lubrication)

#### **SKF Lubrication Systems Germany GmbH**

2. Industriestrasse 4 · 68766 Hockenheim · Germany

Tel. +49 (0)62 05 27-0

Fax +49 (0)62 05 27-101

[www.skf.com/lubrication](http://www.skf.com/lubrication)

